

HLSA12,5-75/3+0

- Lightning impulse current and surge arresters type T1+T2 ensure the equipotential bonding, eliminate the effects of lightning current and reduce switching, induced and residual overvoltage in single-phase and three-phase power supply systems.
- Suitable for objects with considerable levels of protection LPL III and LPL IV, such as small administration complexes, residential buildings, family houses or properties and halls without the incidence of persons and indoor equipment.
- Installed at the boundaries of LPZ 0 – LPZ 1 and higher zones, closest to where overhead line enters the building i.e. in the main distribution boards.
- The products consist of varistors with big discharge ability.
- Configurations 1+1 and 3+1 are additionally combined with a gas discharge tube which ensures zero leakage current through the PE conductor.
- If the product contains two PE (or PEN) terminals, it must not be used as a PE (PEN) bridge.
- **S** indication specifies a version with remote monitoring.

Type		HLSA12,5-75/3+0
Test class according to EN 61643-11:2012 (IEC 61643-11:2011)		T1, T2
System		TN-C
Number of poles		3
Rated operating AC voltage	U_N	60 V
Maximum continuous operating voltage AC	U_C	75 V
Maximum discharge current (8/20)	I_{max}	50 kA
Impulse discharge current for class I test (10/350)	I_{imp}	12.5 kA
Charge	Q	6.25 As
Specific energy for class I test	W/R	39 kJ/ Ω
Total discharge current (10/350) L1+L2+L3->PEN	I_{Total}	37.5 kA
Total discharge current (8/20) L1+L2+L3->PEN	I_{Total}	150 kA
Nominal discharge current for class II test (8/20)	I_n	20 kA
Open circuit voltage of the combination wave generator	U_{OC}	6 kV
Voltage protection level at I_n	U_p	< 0.55 kV
Temporary overvoltage test (TOV) for $t_T = 5$ s	U_T	91 V
Response time	t_A	< 25 ns
Maximal back-up fuse		160 A gL/gG
Short-circuit current rating at maximum back-up fuse	I_{SCCR}	60 kA _{rms}
Lightning protection zone		LPZ 0-1, LPZ 1-2, LPZ 2-3
Housing material		Polyamid PA6, UL94 V-0
Degree of protection		IP20
Operating temperature	θ	-40 ÷ 70 °C
Minimum cross-section of connected Cu conductors accord. to HD 60364-5-53:2022 (doesn't apply to „V“ connection) for T1	S	6 mm ² (L, N) 16 mm ² (PE, PEN)
Minimum cross-section of connected Cu conductors accord. to HD 60364-5-53:2022 (doesn't apply to „V“ connection) for T2	S	2.5 mm ² (L, N) 6 mm ² (PE, PEN)
Clamp fastening range (solid conductor)		1.5 ÷ 25 mm ²

Type		HLSA12,5-75/3+0
Clamp fastening range (stranded conductor)		1.5 ÷ 16 mm ²
Tightening moment		3 Nm
Installation		On DIN rail 35 mm
Modular width		3 TE
Operating position		Any
Signalling at the device		Optic
Importance of local signaling		OK – clear target FAULT – red target
Remote signalling		No
Modular design		No
Lifetime		> 100 000 h
Designed according to standards		
Requirements and test methods for SPDs connected to low-voltage power systems		IEC 61643-11:2011
Safety of Flammability of Plastic Materials		UL 94
Application standards		
Protection against lightning		IEC 62305:2010
Selection and erection of electrical equipment – Switchgear and controlgear		HD 60364-5-53:2022
Selection and application principles for SPDs connected to low-voltage power systems		CLC/TS 61643-12:2009
Ordering, packaging and additional data		
Mass	m	300 g
Mass (including the packaging)	m	324 g
Packaging dimensions (H x W x D)		60 x 113 x 73 mm
Packaging value	V	0.5 dm ³
ETIM group		EG000021
ETIM class		EC001457
Customs tariff no.		85363010
EAN code		8590681113349
Art. number		10 214



The link in the QR code leads to the online presentation of the **HLSA12,5-75/3+0**. There, in addition to the always up-to-date data sheet, you will also find all diagrams and drawings, declarations of conformity, or 2D or 3D models and other necessary materials. For more information, visit www.hakel.com



Application wiring diagram (installation)

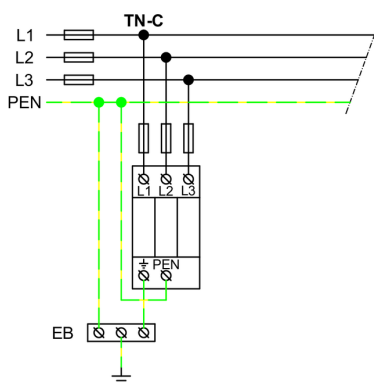

Internal diagram

